

REV.	ECN NO.	DESCRIPTION	DRAW	APPD.	DATE
A	---				

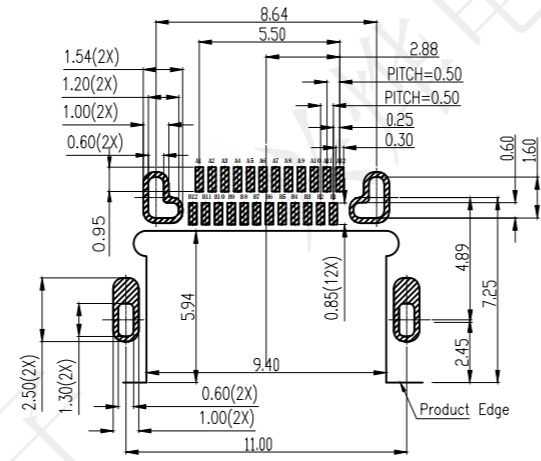

RECOMMENDED PCB LAYOUT(TOP VIEW)

备注:
 1.材质:
 1.1 胶芯: PA9T
 1.2 端子: 高导电C7025, T=0.12mm; 镍底50U", 接触区域镀金(AU 1u") 焊接区镀金G/F
 1.3 外壳: SUS304, T=0.25mm; 表面镀镍30U"
 1.4 中夹片: SUS301, T=0.12mm;
 2.主要特性:
 2.1额定电流: 5A
 2.2接触阻抗: 40mΩ MAX(初始值) 50mΩ MAX(测试后)
 2.3绝缘阻抗: 100MΩ MIN
 2.4耐压测试: 100V AC R.M.S.
 2.6整体插入力: 5-20N 整体插入力: 5-20N(耐久后) 整体拔出力: 8-20N 整体拔出力: 6-20N(耐久后)
 2.7耐久: 10000次
 2.8耐高温: SMT 回流焊(峰值260°±5'), 塑胶不能有起泡, 融胶等不良, 变色, 翘曲变形在公差范围以内;
 2.9产品须做焊锡测试, 粘锡面积达到95%以上;
 3.0盐雾测试: 48H MIN
 3.1工作温度: -30℃~+85℃

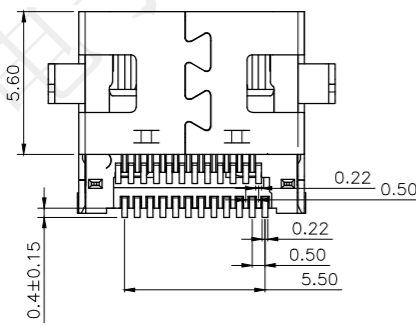
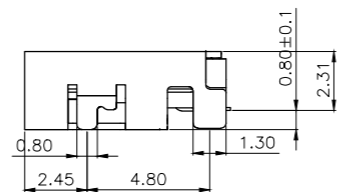
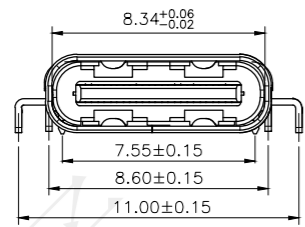
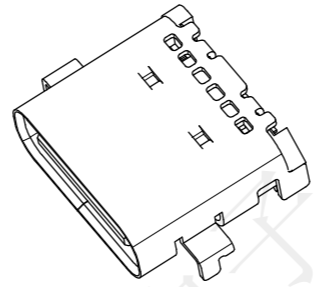
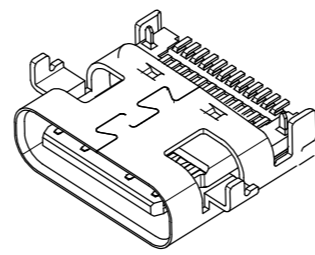
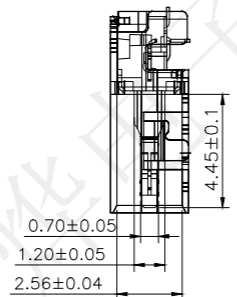
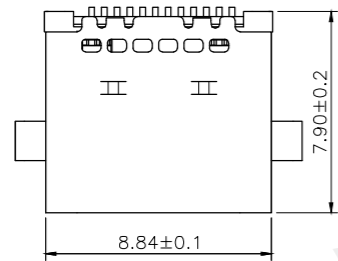

PIN NUMBER	SIGNAL NAME	PIN NUMBER	SIGNAL NAME
A1	GND	B12	GND
A2	SSTXp1	B11	SSRXp1
A3	SSTXn1	B10	SSRXn1
A4	VBUS	B9	VBUS
A5	CC1	B8	SBU2
A6	Dp1	B7	Dn2
A7	Dn1	B6	Dp2
A8	SBU1	B5	CC2
A9	VBUS	B4	VBUS
A10	SSRXn2	B3	SSTXn2
A11	SSRXp2	B2	SSTXp2
A12	GND	B1	GND

5	卡片	不锈钢	
4	接地片	不锈钢	
3	外壳	不锈钢	T=0.25mm 表面镀镍
2	端子	C7025	T=0.12mm 镍底, 镀金
1	胶芯	PA9T	
NO.	Part name	Material	Remarks

深圳市兴烨电子有限公司
 Shenzhen XingYe Electronics co., Ltd

Series Name :
 Product Name :
 TYPE-CF-24P贴片双排沉板0.8

TOLERANCE	
X.X ±0.30	X° ±2°
.XX ±0.20	.X° ±1°
.XXX ±0.10	.XX° ±0.5°
UNITS	mm

Part NO: UCY27636

SCALE	SHEET	REV.
1:1	1/1	A1

受控文件

APPD: 陈爱光
 CHED: 施立敏
 DRAW: 马洪飞

REV.	ECN NO.	DESCRIPTION	DRAW	APPD.	DATE
A	---				

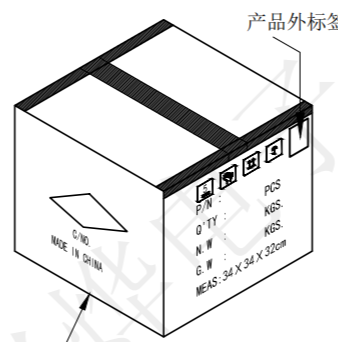
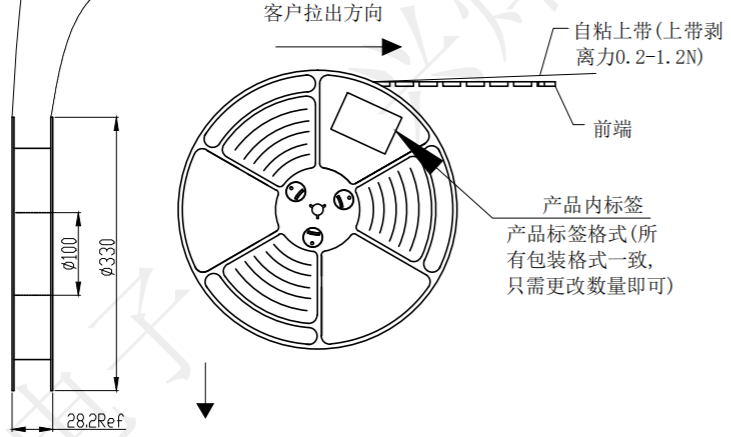
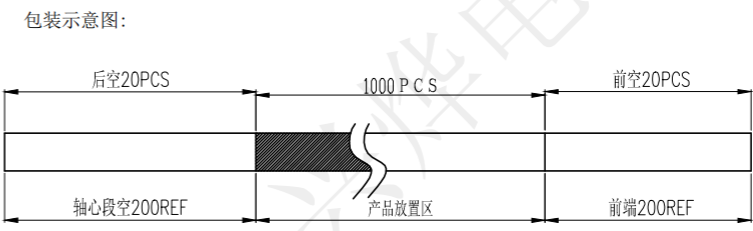
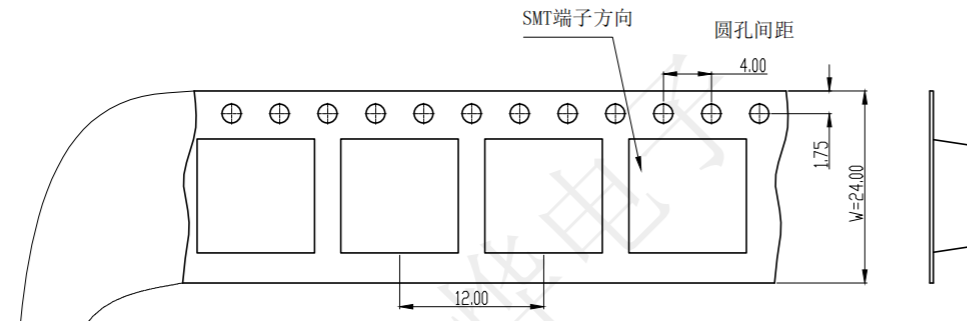

- 备注:
- 1.把上下载带送入载带机进行调整,然后将产品按照指定的方式摆入下载带中,开动卷带机进行卷装(每卷包1000PCS),卷装完成后需用上带缠绕最少20CM;
 - 2.在卷装OK的每卷盘面的指定位置上贴上物料和RoHS标签装入纸箱内;每箱装10盘
 - 3.纸箱用封箱带将其封好,胶带要求工字型,不可遮住标签;
 - 4.如果客户对包装标签另有要求,请按客户要求作业;有未满之零数箱需用缓冲材料填充;
 - 5.上载带剥离力0.2-1.2N.;



受控文件

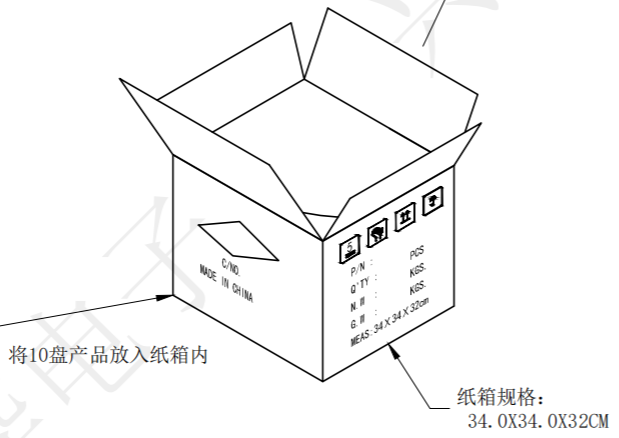

深圳市兴烨电子有限公司 ShenZhen XingYe Electronics co., Ltd		Series Name :	
		Product Name : TYPE-CF-24P贴片双排沉板0.8	
TOLERANCE		Part NO: UCY27636	
X.X ±0.30	X° ±2°	APPD: 陈爱光	SCALE SHEET REV. 1:1 1/1 A1
.XX ±0.20	.X° ±1°	CHED: 施立敏	
.XXX ±0.10	.XX° ±0.5°	DRAW: 马洪飞	
UNITS	mm		