

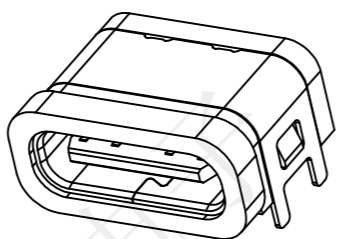

REV.	ECN NO.	DESCRIPTION	DRAW	APPD.	DATE
A	---				

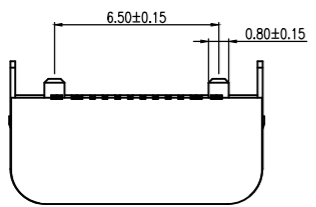

带防水圈3D

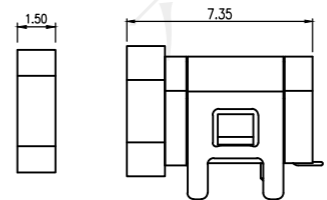
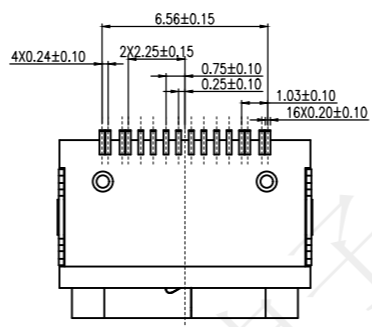
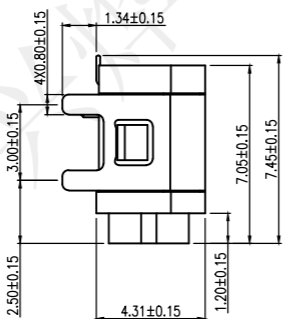
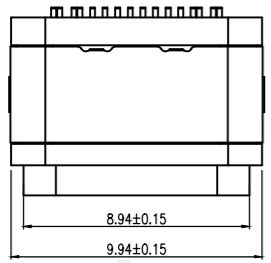
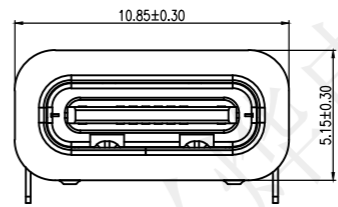

受控文件

NOTES:
SPECIFICATION:

- CURRENT RATING: 5.0A MAX
- VOLTAGE: 100 VAC
- TEMPERATURE RANGE: -30 °C ~ 85 °C
- CONTACT RESISTANCE: 40 MILLIONHM MAX
- INSULATION RESISTANCE: 100 MEGOHMS MIN.
- INSERTION FORCE : 5N~20N
- UNMATING FORCE: 8N~20N
- DURABILITY: 10,000 CYCLES
- WATER PROOFNESS: THIS PRODUCT IS BASED ON IPX6.

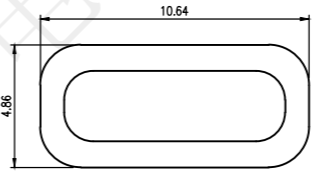
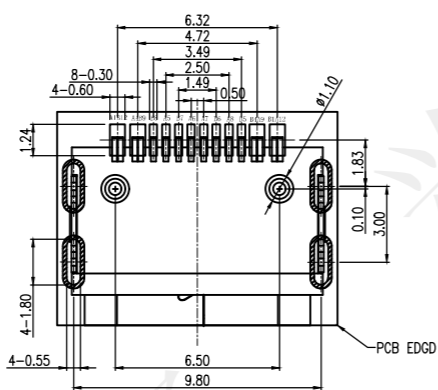
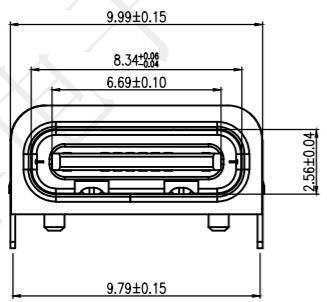

带防水圈示意图

PCB LAYOUT
TOLERANCE SIZE: ±0.05

6	防水圈	硅胶	BLACK	1PCS
5	SHELL	STAINLESS STEEL	NI Plated	1PCS
4	SHIELDING PLATE	STAINLESS STEEL	NI Plated	1PCS
3	CONTACT	COPPER ALLOY 高导电铜	TIN/Au/NI Plated	1SET
2	SHELL HOUSING	HIGH TEMPERATURE PLASTIC	BLACK	1PCS
1	HOUSING	HIGH TEMPERATURE PLASTIC	BLACK	1PCS
NO.	DESCRIPTION	MATERIAL	REMARKS	QTY

A1	GND	B12	GND
A4	VBUS	B9	VBUS
A5	CC1	B8	SBU2
A6	DP1	B7	DN2
A7	DN1	B6	DP2
A8	SBU1	B5	CC2
A9	VBUS	B4	VBUS
A12	GND	B1	GND
PIN	SIGNAL NAME	PIN	SIGNAL NAME



TOLERANCE	
X.X ±0.30	X.° ±2°
.XX ±0.20	.X° ±1°
.XXX ±0.10	XX° ±0.5°
UNITS	mm

APPD: 陈爱光
CHED: 施立敏
DRAW: 马洪飞

Series Name :		
Product Name : TYPE-CF-16P板上四脚插L7.05高导电铜防水IPX6		
Part NO: UCX27616		
SCALE 1:1	SHEET 1/1	REV. A1

