

REV.	ECN NO.	DESCRIPTION	DRAW	APPD	DATE
A	---				

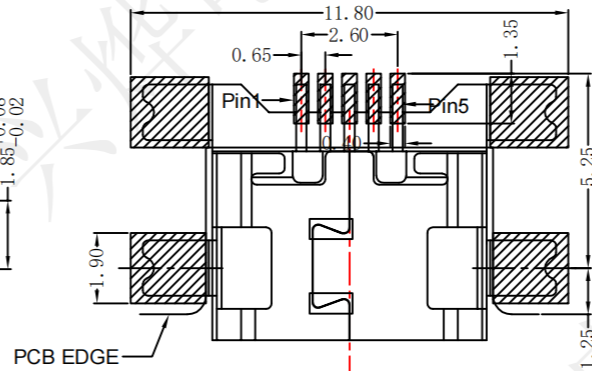
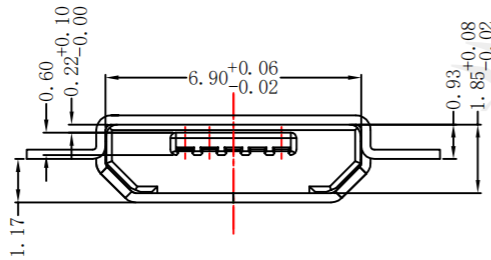
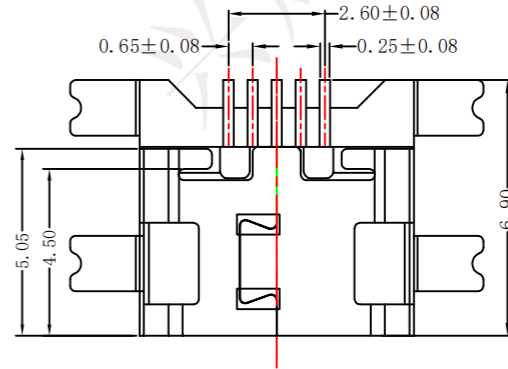
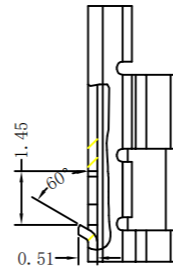
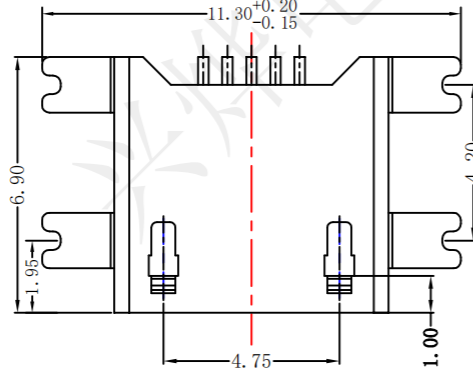
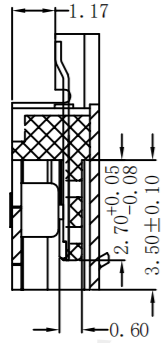
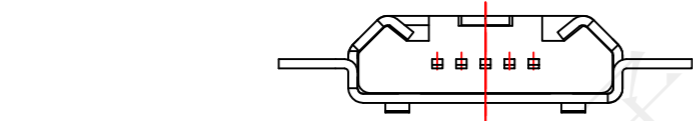

受控文件

Specification:
 Current rating: 1,5PIN 1.8A Max/2,3,4PIN 1A Max.
 Contact resistance: 30 mΩ Max.
 Insulation resistance: 100 MΩ Min.
 Total mating force: 3.57 Kgf Max.
 Total unmating force: 1.0 Kgf Min.
 Temperature range: -30°C~80°C

RECOMMENDED PCB LAYOUT
 PCB图仅供参考



MKF26105	MICRO-5P 沉板 1.17四脚贴平口铜雾锡编带
MKF26106	MICRO-5P 沉板 1.17四脚贴平口铜镀镍编带
MKF26107	MICRO-5P 沉板 1.17四脚贴平口不锈钢雾锡编带
MKF26108	MICRO-5P 沉板 1.17四脚贴平口不锈钢镀镍编带

深圳市兴烨电子有限公司
 Shenzhen XingYe Electronics co., Ltd

Series Name :
 MICRO-5P 沉板 1.17四脚贴平口编带
 Product Description :

3	Shell	1PCS	copper alloy/SUS304	t=0.25mm
2	Contacts	5PCS	copper alloy	t=0.20mm
1	Housing	1PCS	LCP	UL94v-0
No.	Pare Name	Number	Material	Remarks

TOLERANCE				
X.X	±0.30	X.°	±2°	APPD: 陈爱光
.XX	±0.20	.X°	±1°	CHED: 施立敏
.XXX	±0.10	.XX°	±0.5°	DRAW: 马洪飞
UNITS	mm			

Part NO:		
	SCALE	SHEET
	1:1	1/1
		REV.
		A1

