

REV.	ECN NO.	DESCRIPTION	DRAW	APPD.	DATE
A	---				

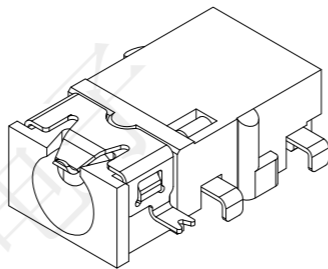
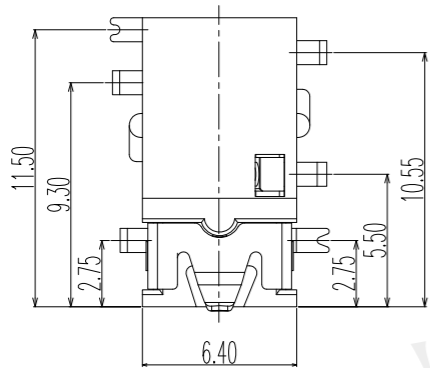

3D VIEW

NOTES:

- CONTACT CURRENT RATING: 1A.
- CONTACT RESISTANCE: 150 mΩ MAX.;
- INSULATION RESISTANCE: 1000MΩ MIN.;
- DIELECTRIC WITHSTANDING: 500V AC MIN.;
- DURABILITY: 5,000 CYCLES MIN.;
- CONNECTOR MATING FORCES: 30N MAX.;
- CONNECTOR UNMATING FORCES: 3N MIN.;

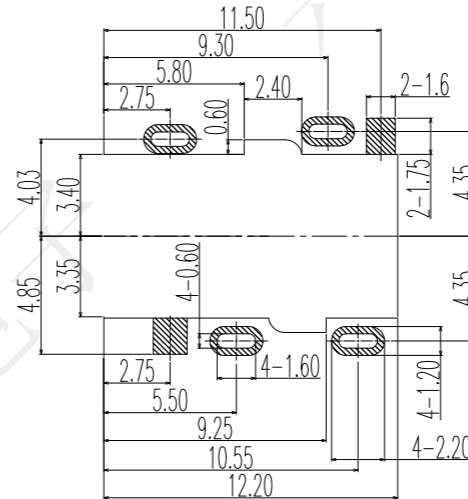
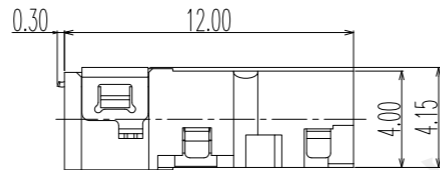
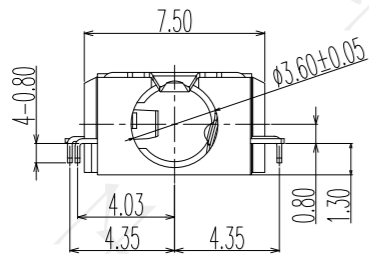

P.C.B LAYOUT  
TOP VIEW



受控文件

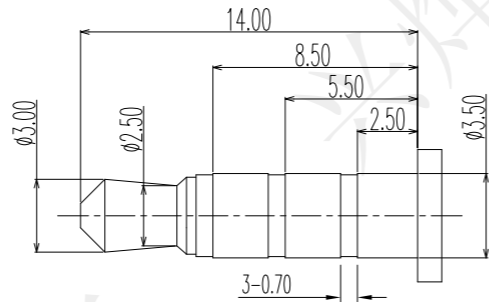
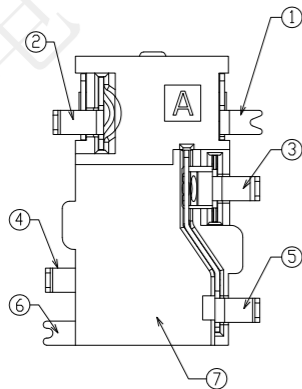

(ø3.50mm 4 POLE PLUG DETAIL DRAWING)

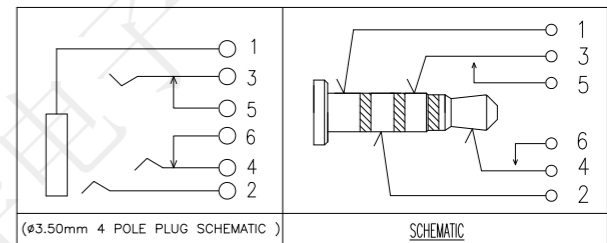

(ø3.50mm 4 POLE PLUG SCHEMATIC)

SCHEMATIC

⑦	HOUSING	1	HIGH TEMPERATURE; COLOR BLACK	
⑥	CONTACT 6#	1	STAINLESS STEEL; NICKEL UNDER PLATING OVERALL, GOLD FLASH ON SOLDER AREA	T=0.2
⑤	CONTACT 5#	1	STAINLESS STEEL; NICKEL UNDER PLATING OVERALL, GOLD FLASH ON SOLDER AREA	T=0.2
④	CONTACT 4#	1	PHOSPHOR BRONZE; NICKEL UNDER PLATING OVERALL, GOLD FLASH PLATING ON SOLDER AREA; GOLD FLASH PLATING ON CONTACT AREA	T=0.2
③	CONTACT 3#	1	STAINLESS STEEL; NICKEL UNDER PLATING OVERALL, GOLD FLASH PLATING ON SOLDER AREA; GOLD FLASH PLATING ON CONTACT AREA	T=0.2
②	CONTACT 2#	1	PHOSPHOR BRONZE; NICKEL UNDER PLATING OVERALL, GOLD FLASH PLATING ON SOLDER AREA; GOLD FLASH PLATING ON CONTACT AREA	T=0.2
①	CONTACT 1#	1	STAINLESS STEEL; NICKEL UNDER PLATING OVERALL, GOLD FLASH ON OVERALL;	T=0.2
ITEM	PART NAME	Q'TY	MATERIAL	REMARK

深圳市兴烨电子有限公司  
Shenzhen XingYe Electronics Co., Ltd

TOLERANCE	
X.X ±0.30	X° ±2°
.XX ±0.20	.X° ±1°
.XXX ±0.10	.XX° ±0.5°
UNITS	mm

APPD: 陈爱光  
CHED: 施立敏  
DRAW: 马洪飞

Series Name :		
Product Name : PJ-35A013后四脚插		
Part NO: PJX22039		
SCALE	SHEET	REV.
1:1	1/1	A1