

REV.	ECN NO.	DESCRIPTION	DRAW	APPD.	DATE
A	---				

- CONTACT CURRENT RATING: 0.5A.
- CONTACT RESISTANCE: 30mΩ MAX.;
- INSULATION RESISTANCE: 100MΩ MIN.;
- DIELECTRIC WITHSTANDING: 500V AC MIN.;
- DURABILITY: 5,000 CYCLES MIN.;
- CONNECTOR MATING FORCES: 30N MAX.;
- CONNECTOR UNMATING FORCES: 3N MIN.;
- Operating temperature: -30° C~70° C

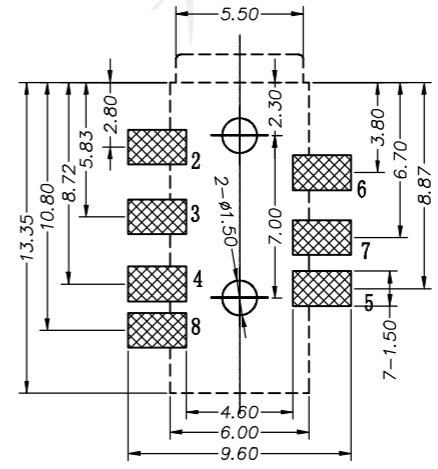

P.C.B LAYOUT TOP VIEW

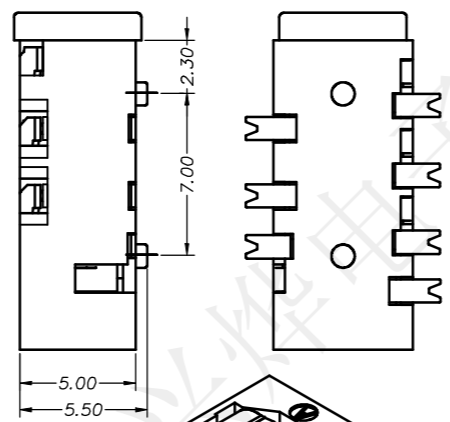
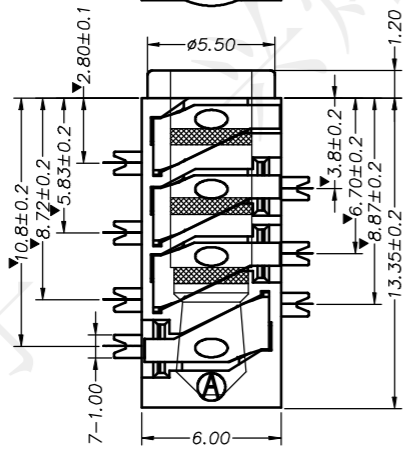
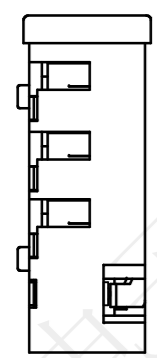
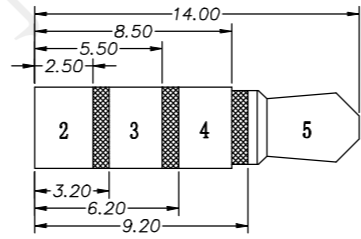
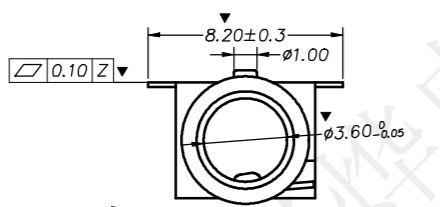
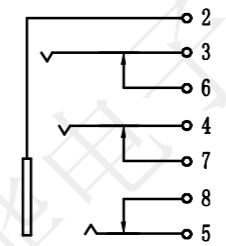
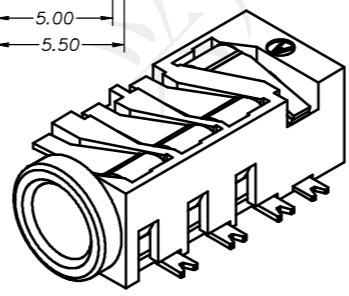
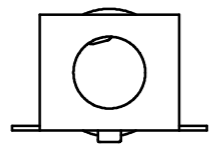

受控文件

4	短脚	1	磷铜	0.2T	镀金
3	长脚	2	磷铜	0.2T	镀金
2	弹片脚	4	磷铜 TT	0.25T	镀金
1	底座	1	PPA		黑色
序号	产品名称	数量	材料	规格	处理

**深圳市兴烨电子有限公司**  
Shenzhen XingYe Electronics Co., Ltd

TOLERANCE

X.X ±0.30	X.° ±2°	APPD: 陈爱光
.XX ±0.20	.X° ±1°	CHED: 施立敏
.XXX ±0.10	.XX° ±0.5°	DRAW: 马洪飞

UNITS mm

Series Name :		
Product Name : PJ-382贴片编带		
Part NO: PJL22020		
SCALE	SHEET	REV.
1:1	1/1	A1