

REV.	ECN NO.	DESCRIPTION	DRAW	APPD.	DATE
A	---				

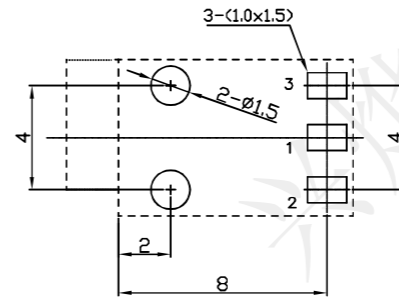

PCB LAYOUT TOP VIEW

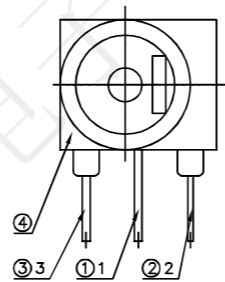
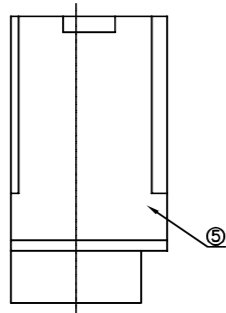
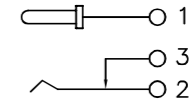

CIRCUIT DIAGRAM

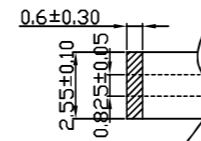
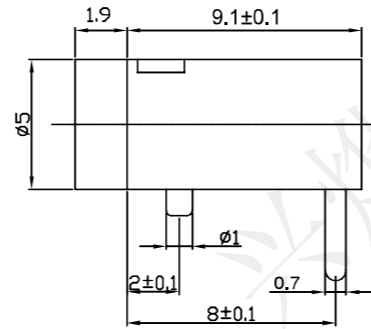
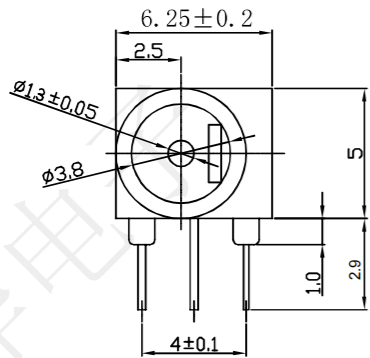

SPECIFICATION:
 Operating temperature: -40°C~55°C
 Rated loading: DC 30V 0.5A
 Contact resistance: 30mΩ Max
 Insulation resistance: 100MΩ Min
 Withstanding voltage: AC 500V (50Hz) /min
 Insertion force: 3-20N
 Pullout force: 3-20N
 Life: 5000 CYCLES

受控文件

⑤	COVER	1	PA66 (BLACK)	
④	HOUSING	1	PA66 (BLACK)	
③	TERMINAL	1	BRASS t=0.3	Ag-Plated
②	TERMINAL	1	SUS301 t=0.2	Ag-Plated
①	TERMINAL	1	BRASS t=0.3	Ag-Plated
No.	PART NAME	QTY	MATERIAL (THICK, COLOR)	REMARK

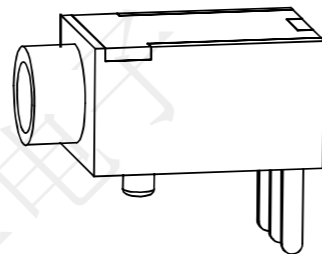

深圳市兴烨电子有限公司 Shenzhen XingYe Electronics co., Ltd		Series Name :	
		Product Name : DC-003A-1.3半铜	
TOLERANCE		Part NO: DCS19013	
X.X ±0.30	X.* ± 2*	APPD: 陈爱光	SCALE SHEET REV. 1:1 1/1 A1
.XX ±0.20	.X* ± 1*	CHED: 施立敏	
.XXX ±0.10	.XX* ±0.5*	DRAW: 马洪飞	
UNITS	mm		