

REV.	ECN NO.	DESCRIPTION	DRAW	APPD.	DATE
A	---				

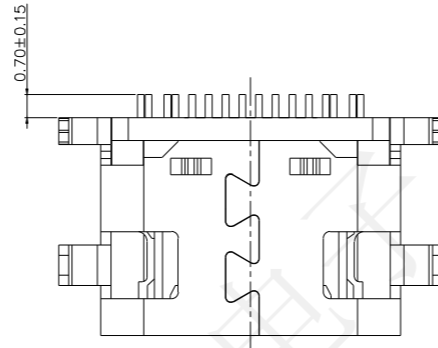
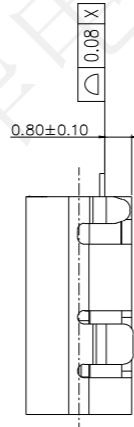
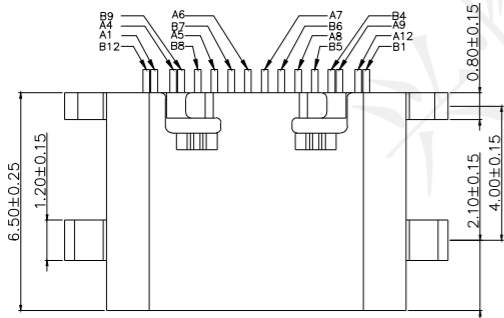
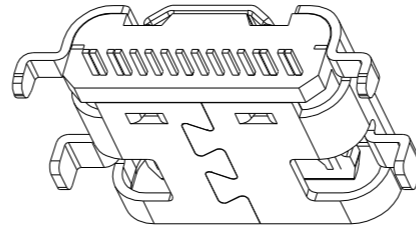
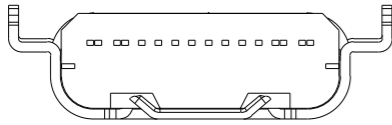

Electrical

1.1.Rated Voltage:30V AC/DC maximum
 1.2.CURRENT RATING: PIN A4,B4,A9,B9 3A,
 PIN A1,B1,A12,B12 1.25A,OTHER PIN
 0.25A MIN.

1.2.INSULATION RESISTANCE:100MΩ MIN
 1.2.CONTACT RESISTANCE:50mΩ MAX

Mechanical

2.3.INSERT FORCE: 5~20N;
 2.3.EXTRACT FORCE:INITIAL 8~20N,
 AFTER 10000 CYCLES 6~20N;
 2.3.DURABILITY: 10000 CYCLES

Plating

3.1.Terminal:Contact area:1u" gold plate
 over 50u" NI min.Solder area:100u"
 pure TIN plate over 50u" NI min.

3.2.Shell: Ni:100u"min.

4.Ambient Temperature:-30°C To +85°C

受控文件



A1	GND	B12	GND
A4	VBUS	B9	VBUS
A5	CC1	B8	SBU2
A6	DP1	B7	DN2
A7	DN1	B6	DP2
A8	SBU1	B5	CC2
A9	VBUS	B4	VBUS
A12	GND	B1	GND
PIN	SIGNAL NAME	PIN	SIGNAL NAME

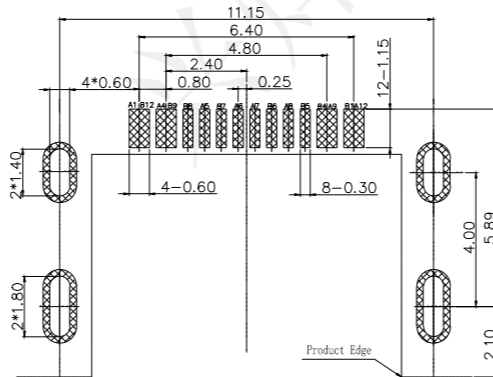
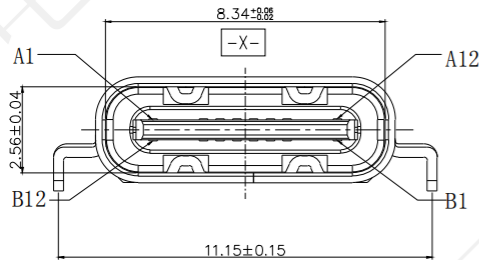

RECOMMENDED P.C.B. LAYOUT
 TOLERANCE UNSPECIFIED ±0.05mm

4	Front shell	SUS201	Ni/SN plated
3	Mid plate	SUS301	
2	Contact	黄铜	Au/Ni plated
1	Housing	LCP	Black
NO.	Part name	Material	Remarks

深圳市兴烨电子有限公司
 Shenzhen XingYe Electronics co., Ltd

TOLERANCE	
X.X ±0.30	x.° ±2°
.XX ±0.20	.X° ±1°
.XXX ±0.10	.XX° ±0.5°
UNITS	mm

APPD: 陈爱光
 CHED: 施立敏
 DRAW: 马洪飞

Series Name :		
Product Name :	TYPE-CF-16P沉板0.8四脚插黄铜SUS201	
Part NO:	UCY27449	
SCALE	SHEET	REV.
1:1	1/1	A1