

REV.	ECN NO.	DESCRIPTION	DRAW	APPD.	DATE
A	---				

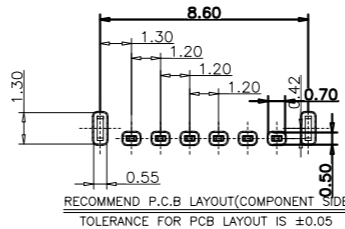
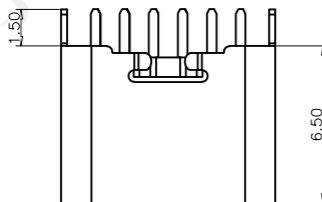
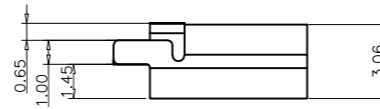
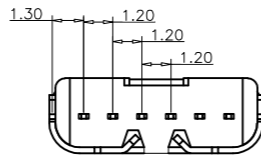
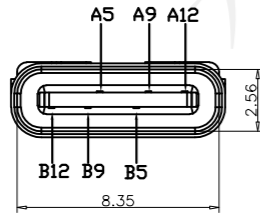
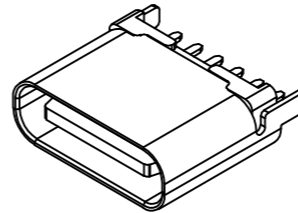
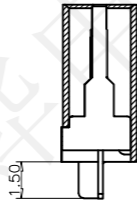
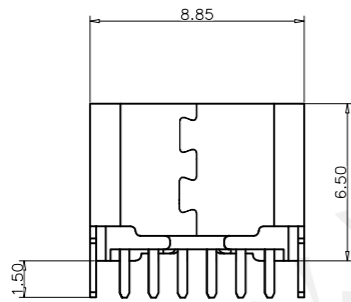

备注 (NOTE):

1. 材质:

- 1.1 胶芯: LCP UL94 V-0
- 1.2 端子: C2680, T=0.2mm; 镍底, 镀金
- 1.3 外壳: 不锈钢201-H 表面镀镍

2. 电气特性:

- 2.1 接触区: 接触电阻40mΩ Max, 允许10mΩ变化量. 测试条件: 20mv, 100mA下测量.
  - 2.2 接触电流: 3A VBUS引脚; 1.25A用于GND引脚; 其他引脚为0.25A.
  - 2.3 额定电压: 5V.
  - 2.4 耐电电压: 100VAC.
  - 2.5 绝缘电阻: 至少100兆欧.
3. 机械性能:
- 3.1 插入力: 0.5-2.0Kg
  - 3.2 拔出力: 0.6-2.04Kg
  - 3.3 插拔次数: 5000次.
  - 4. 工作环境: -20°C to +85°C.

USB TYPE C PIN ASSIGNMENTS

PIN NUMBER	SIGNAL NAME	PIN NUMBER	SIGNAL NAME
		B12	GND
		B9	VBUS
A5	CC1	B5	CC2
A9	VBUS		
A12	GND		

TABLE:

NO	PART	Q'TY	Material
1	SHELL	1	ZINC ALLOY, NI30u"Min PLATED
2	CONTACT	6	C2680, TIN80u"/Au1u"/NI30u" PLATED
3	1MD HOUSING	1	LCP UL94 V-0 BLACK
4	CAP	1	LCP UL94 V-0 BLACK
5	WATERPROOF RING	1	SILICONE UL94 V-0 BLACK



受控文件

深圳市兴烨电子有限公司  
ShenZhen XingYe Electronics co., Ltd

TOLERANCE		
X.X	±0.30	X.° ±2°
.XX	±0.20	.X° ±1°
.XXX	±0.10	.XX° ±0.5°
UNITS	mm	

Series Name :		
Product Name :	TYPE-CF-6P直插H6.5	
Part NO:	UCZ17434	
SCALE	SHEET	REV.
1:1	1/1	A1

APPD: 陈爱光  
CHED: 施立敏  
DRAW: 马洪飞